



Tractors

AXION

960 950 940 930 920

**CLAAS**



Ready.  
The AXION 900.



The first half-track tractor with full suspension.

The AXION 900 has always been ready to take on those really big challenges: with powerful engines delivering up to 445 hp, continuously variable CMATIC driving comfort and enormous tractive power, which we have stepped up yet again. Now the AXION 900 TERRA TRAC has arrived – the first half-track tractor with full suspension.

**Make the most of its strengths.**

- Get 15% more traction and 50% less ground pressure with TERRA TRAC
- Go from 0.05 to 50 km/h with simple, continuously variable transmission
- Make significant fuel savings with the low-speed concept
- Make you and your drivers even better with CEMOS
- Operate the tractor intuitively via the 12" CEBIS touchscreen
- Perform every turning manoeuvre at the press of a button with the CSM headland management system and TURN IN steering system



CLAAS tractors:  
from the idea to the  
machine.

[tractors-making-of.claas.com](https://tractors-making-of.claas.com)



AXION 900 TERRA TRAC. More traction, less ground pressure.  
Page 24



CEMOS for tractors. Makes good operators even better.  
Page 58



Camera images in CEBIS. Adjustable and straightforward.  
Page 46

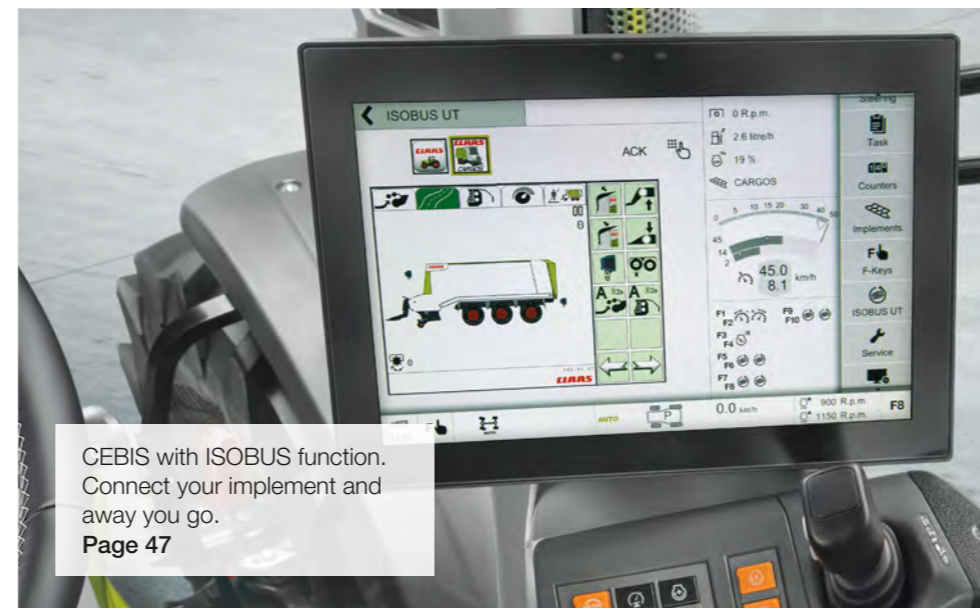

CEBIS with ISOBUS function. Connect your implement and away you go.  
Page 47



Rear PTO. The right engine speed for every implement.  
Page 30

<b>CEMOS – your on-board CLAAS advisor</b>	<b>6</b>
<b>TERRA TRAC concept</b>	<b>8</b>
<b>CLAAS POWER SYSTEMS (CPS)</b>	<b>10</b>
Engine	12
CMATIC	14
Construction	20
TERRA TRAC	24
Safety	28
PTO	30
Hydraulics	32
Rear linkage	34
Front linkage	36
<b>Cab and comfort</b>	<b>38</b>
Versions	40
CEBIS	42
CIS+	48
Comfort	52
<b>Operator assistance systems and data management</b>	<b>56</b>
CEMOS	58
CSM headland management	60
ISOBUS	62
Steering systems	64
Job management, <b>TELEMATICS</b>	<b>66</b>
Maintenance	68
CLAAS Service & Parts	72
Features	74
Specifications	75



More innovation: more details here.

[axion900.claas.com](http://axion900.claas.com)

# CEMOS – makes good operators even better.

The name CEMOS refers to all CLAAS systems which optimise machine performance. For several years CEMOS has been the leading operator assistance system for CLAAS combine harvesters and now it is available for tractors too.

#### What is CEMOS?

Think of CEMOS as your on-board CLAAS advisor, there to assist you with your daily work. The system suggests setting values and helps the driver continually adjust the machine to the field conditions. CEMOS takes the hassle out of settings and quickly helps the driver optimise machine performance.

#### The advantages of CEMOS.

- Increases work rate by 11%
- Reduces fuel consumption by 12%
- Reduces tyre wear
- Reduces operating costs by increasing work rates
- Utilises the full potential of the machine
- Reduces implement wear (plough assistant)
- Improves the carbon footprint of your farm

**CEMOS makes good operators even better in three simple steps. See page 58 to find out more.**



Get the job done quickly and efficiently.  
[ceмос.claas.com](https://ceмос.claas.com)



# An outstanding solution for your farm.



## Our soil – a precious resource.

Soil is the very foundation of agricultural production. But it's a finite resource. Farms are increasing in size and the windows for cultivation and harvesting are becoming ever shorter. At the same time, machines are getting bigger, more powerful – and heavier. This leads to soil compaction.

Modern agriculture protects the soil right from the start and avoids excessive compaction. So you don't have to invest time or money on deep tillage to rectify the damage.

## Think holistically.

The advantages of the TERRA TRAC have proved themselves on CLAAS combine harvesters for over 20 years. In order to make full use of the system's potential, we must take an integrated approach to soil protection. This means treating the soil gently throughout every process in the chain.

It was a logical step for CLAAS to extend the TERRA TRAC concept to tractors and forage harvesters so that farmers and contractors can manage their soil – the basis of their livelihood – sustainably, from drilling through to harvest.

## Drive the AXION 900 TERRA TRAC.

The AXION 900 TERRA TRAC from CLAAS is the first half-track tractor with full suspension. The integrated, innovative TERRA TRAC crawler track assembly is based on technology currently used in combine harvesters that we have specially adapted to meet the requirements of tractors. The AXION 900 TERRA TRAC combines the advantages of a tracked tractor in terms of traction and soil protection with the more comfortable drive characteristics of a conventional tractor. As a new solution for modern, efficient agriculture, the AXION 900



TERRA TRAC was awarded a silver medal at Agritechnica 2017.



TERRA TRAC – the story of an innovation.

### AXION 900 TERRA TRAC – the first half-track tractor with full suspension.

#### 15% more traction.

- Larger implements
- Less slippage
- Lower working speed means less wear
- Lower fuel consumption

#### 35% larger footprint, 50% less ground pressure.

- Protects soil fertility
- Fewer tracks reduce tillage costs
- Saves costs of subsequent tillage

#### 100% driving comfort.

- As comfortable as a standard tractor
- The operator maintains a high level of concentration, even on long working days

#### 100% flexibility.

- Does not exceed statutory 3.0 m road width limit
- Same steering characteristics as a standard tractor, so new operators feel at home straight away
- Highly versatile
- Suitable for any terrain

Our drive system: the perfect interplay between optimal components.

Your CLAAS machine is much more than the sum of its individual parts. Top performance is only possible when all the parts are ideally matched and work together optimally.

In CLAAS POWER SYSTEMS (CPS), we have brought together top-quality components to create an intelligent drive system that sets new standards. Full engine output only when you need it. Drives that are suited to the way your machines are used. Fuel-saving technology which quickly pays off.



# More power and torque – lower engine speed and better fuel economy.

## Pure power.

The AXION 900 is designed for transport work as well as field work. That's why it delivers its full engine output – without a boost – for every type of job. Even heavy tillage at low speeds is no problem. Thanks to CMATIC powertrain management, the AXION 900 employs a low-speed concept: higher output at lower engine speeds and automatic engine speed adjustment reduce operating costs.

A 6-cylinder, 8.7 litre FPT Cursor 9 engine gets to work under the one-piece bonnet. It meets the requirements of the Stage IV (Tier 4) emissions standard and is equipped with the latest common rail 4-valve technology, charge-air cooling and a variable geometry turbo (VGT).

## Variable turbo.

The VGT turbo delivers optimum charge-air pressure at any engine speed. It adjusts to load and engine speed, making 70% of maximum torque available even when idling. Optimised combustion therefore means low fuel consumption and maximum performance.

## Low-speed concept.

Higher output with lower fuel consumption – this was the goal CLAAS engineers wanted to achieve when developing the innovative low-speed concept for CMATIC tractors.

### Further benefits include greater convenience and longer working hours on one tank of fuel:

- Constant output range of 1,700 to 1,900 rpm
- Constant torque range of 1,300 to 1,500 rpm
- 95% of max. output available at the 1000 ECO rear PTO (1,400 or 1,600 rpm)
- Two idling speeds (650 and 800 rpm) with automatic adjustment reduce stationary fuel consumption by up to 2 l/h

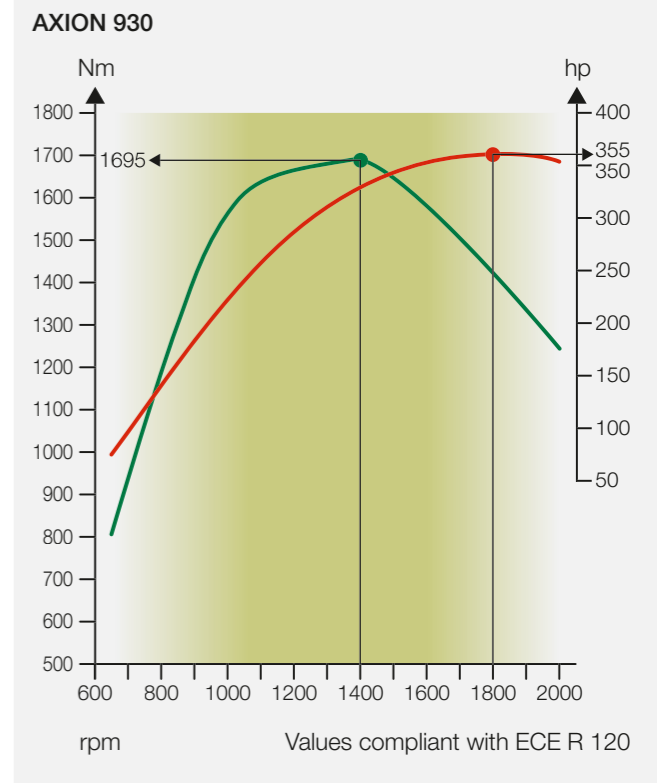

## Integrated SCR system.

When designing the AXION 900 series, the components required for exhaust gas aftertreatment were considered from the outset. The diesel oxidation catalytic converter (DOC) is positioned under the bonnet immediately behind the turbocharger because it needs high exhaust temperatures to produce an optimum reaction. The SCR catalytic converter is an integral part of the exhaust system and is located on the right-hand side of the tractor right behind the A-pillar in the cab, where it does not compromise driver visibility and machine accessibility.

## Visctronic – efficient fan control.

With Visctronic electronic fan control the fan speed can be precisely aligned with engine temperature and load, ensuring that the engine always runs at the optimum temperature. The reduced fan speed lowers the noise level and saves valuable fuel with no unnecessary impact on output, which can then be converted into tractive power.

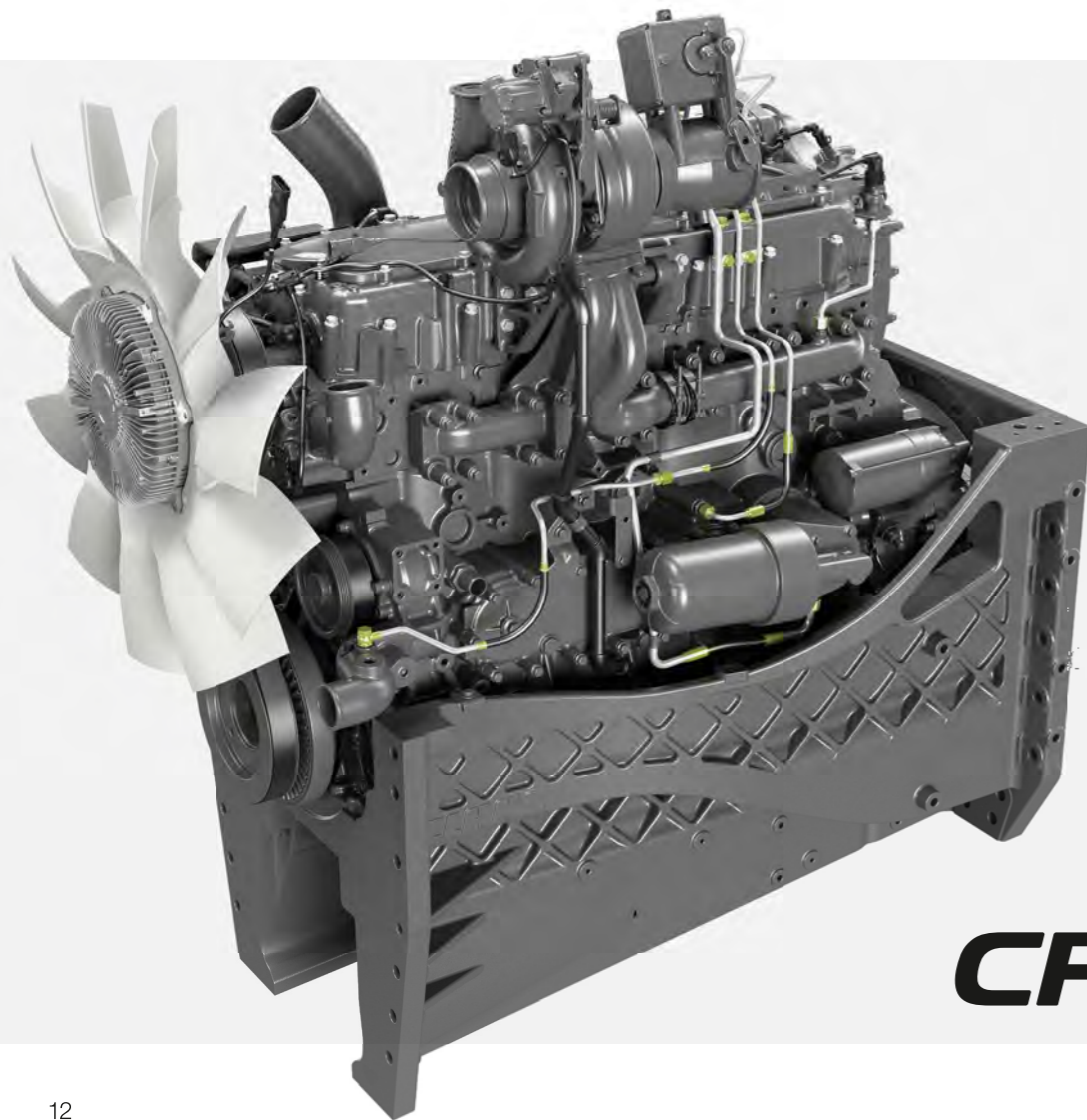

**CPS** | CLAAS POWER SYSTEMS

AXION	Torque (Nm)	Maximum output (hp) ECE R 120
960	1860	445
950	1820	410
940	1770	385
930	1695	355
920	1600	325



# CLAAS CMATIC. Continuously variable.



**CPS** | CLAAS  
POWER  
SYSTEMS



## Efficient and user-friendly.

CMATIC is the name of the continuously variable transmission technology used in CLAAS tractors. In the AXION 900 series a ZF Terramatic transmission provides efficient conversion of engine power. In this split-power, continuously variable transmission, the four mechanical ranges are automatically selected by multidisc clutches. There is no need to shift between ranges manually.

The high mechanical component in the power transmission provides outstanding efficiency and low fuel consumption in every speed range.

## Superior transmission control.

Powerful acceleration, smooth deceleration and a fast response to changes in load: CMATIC powertrain management shows its capabilities in all conditions and for every task. Stay relaxed and focused throughout the working day so you can concentrate on more important things – CMATIC does the rest for you.



## Exploiting real potential.

The full power of the transmission can be used at speeds from 0.05 to 50 km/h. The high level of mechanical power transmission also delivers outstanding driving force in reverse. What's more, every gear ratio can be used at every engine speed, giving AXION 900 tractors enormous potential for use all year round.

With engine speeds of 1,600 rpm at a top speed of 50 km/h and 1,400 rpm at 40 km/h, the AXION 900 also demonstrates its capabilities in transport operations. If the accelerator is not depressed, the transmission is in powered zero mode and maintains its position without creeping or rolling. This means that the tractor can start up safely and easily at steep field entrances or road junctions, even with a full load.



# CMATIC. Optimised settings.



Engine droop setting for "Eco" and "Power", and the engine speed memory.

## Engine droop at the push of a button.

The engine droop value can be used for quick and easy regulation of the engine speed under full load. The CEBIS or CIS terminal clearly displays the engine speed at which the transmission reduces the speed.

When a constant engine speed is activated, i.e. during PTO work, the driver can specify a different droop setting, typically one that matches the engine speed to the required PTO shaft speed.

Two engine droop values can be saved for engine droop in accelerator pedal and drive lever mode. They are retrieved by the quick-access facility using the F buttons. With these values, known as "Eco" and "Power", the droop can be rapidly adjusted to the task in hand, e.g. when moving from the road to the field. The engine droop for the engine speed memory is defined separately.



## Simple, straightforward operation.

The CMATIC transmission has three operating modes: accelerator pedal, drive lever and manual mode.

In the first two modes, forward speed can be controlled by the accelerator pedal or drive lever. The engine speed and transmission ratio are adjusted automatically – for optimum efficiency and optimised fuel consumption. In manual mode, the driver chooses the engine speed and transmission ratio. Automatic engine and transmission control is disabled.

## Accelerator pedal or drive lever.

You can switch between accelerator pedal and drive lever mode while the tractor is moving by pressing a button on the armrest. The active mode is displayed in the CEBIS or CIS.



Driving mode display in the CEBIS.

# CMATIC. No need to stop.



## Tailor-made speed ranges.

With the CMATIC transmission, three speed ranges can be pre-selected in both directions of travel. The active range is displayed in the CEBIS or CIS and can be changed while the tractor is in motion using two buttons. The lower the maximum preset value for the range, the more accurately the forward speed can be controlled.

A cruise control speed can be saved for all the ranges while the tractor is moving by pressing the button on the drive lever. The cruise control speeds can also be pre-set on the CEBIS or CIS terminal.

CMATIC allows drivers to create their own profiles according to the job in hand. Intelligent CMATIC transmission technology enables you to use the full power of your AXION economically and productively – with maximum operator comfort.

## Stopping power.

The CMATIC transmission offers different ways of adapting braking to the job in hand.

### Increase the engine braking effect:

When the accelerator pedal is released and the multifunction control lever is pulled back, the transmission ratio is reduced, causing the engine speed to increase. The optional engine retarder also comes into play. It engages automatically when it is needed and increases the engine braking effect by up to 2.5 times. This reduces brake wear.

### Anti-jackknife brake:

When the trailer is braked with the service brake, you can accelerate at the same time using the accelerator pedal or by pressing the multifunction control lever. This maintains the distance between the tractor and trailer on steep hills and increases safety. These functions can be used whether the tractor is stationary or moving.

CIS+ operation

- 1 Change range
- 2 Activate cruise control



Stable and manoeuvrable.  
Immense tractive power.



Real stability.  
The true sign of a 400 hp tractor.

CLAAS has drawn on experience gained in developing standard tractors and XERION large tractors delivering 500 hp or more to create a completely new solution for the AXION 900 – for endurance work under extremely challenging conditions. The engine is housed in a strong frame section (1) with an integrated engine oil sump (2) which perfectly absorbs all the forces associated with the front linkage and front axle carrier (3).



In practice, this means:

- Maximum stability even when using heavy front-mounted implements
- Front axle has excellent steering lock angle (3) for maximum manoeuvrability
- Optimum access to the entire engine compartment and all maintenance points
- All services securely routed within the frame section

Long wheelbase – compact design

To transfer 400 hp to the ground, the design must be just right. The AXION 900 ticks all the boxes. It has a wheelbase of 3.15 m, but its outstanding design makes it manoeuvrable in the field and easy to drive on the road. And naturally, its overall length with an implement attached remains within the legal limits. Additional front ballast is not needed for many tasks – particularly transport operations – as the long wheelbase and optimum weight distribution transfer the tractor's tractive power to the ground. This saves fuel and reduces tyre wear on the road.



**Short overall length:**

- Good manoeuvrability
- Short trailer combination on the road
- Good visibility
- Good guidance of front-mounted implements



**Good power to weight ratio:**

- Optimises fuel consumption
- Low ground pressure during tillage
- Dynamic road transport
- 50 : 50 weight distribution front / rear



Fully balanced.

With so many front and rear axle ballast options, the AXION is easily adapted to every application. This is the only way to utilise its full performance potential without unnecessary losses. If you need to carry out heavy work at low speeds, you can increase the ballasting on the AXION very easily. Weight that is no longer needed can also be removed quickly.

For flexible ballasting on the fixed weight carrier or front linkage, the combinations available ex factory are as follows:

- 600 kg
- 900 kg
- 1,200 kg (600 + 600)
- 1,500 kg (900 + 600)
- 1,800 kg

38" rim	42" rim
100	400
367	667
634	856



A broad base.

The rear tyres on all AXION 900 models can be up to 2.20 m in diameter. Tyres up to 1.70 m diameter are used on the front axle. The numerous tyre options make the AXION 900 capable of any type of work. Even with the biggest tyres (900/60 R 42) the tractor has an external width of less than 3.0 m, making it flexible on the road and gentle on the field. The AXION 900 can also be fitted with dual tyres.<sup>1</sup>

The footprint of the AXION 900:

- Rear tyres up to 900 mm wide with 900/60 R 42
- Rear tyres up to 2.20 m diameter with 750/70 R 44
- Front tyres up to 1.70 m in diameter
- Flange-mounted dual tyres on quick-release axle even for heavy traction work



CTIC tyre pressure adjustment system.

The right tyre pressure protects the soil and benefits the yield in the long term. But it offers other economical advantages too, such as increased tractive power, reduced fuel consumption and low tyre wear. The spool valves are integrated into the patented rotary transmitters to ensure direct high-precision tyre pressure measurement and control at the wheel. The tyre pressure is continually monitored and automatically adjusted.

In the basic version, the CTIC is supplied by the tractor compressor. The CTIC 2800 version has its own screw compressor with an airflow rate of 2,800 l/min. We recommend the CTIC 2800 if you frequently switch from field to road or want to adjust the tyre pressure to suit the trailed implement.



<sup>1</sup> Dual tyres are not available in all countries. Please refer to your dealer's price list.



### Low ground pressure safeguards future harvests.

The footprint of the crawler track assembly depends on the width of the track. If the front tyre contact area is included, it can be up to 4.0 m<sup>2</sup>. That's 1.0 m<sup>2</sup> or 35% more than that of a standard tractor. This has a positive impact on your soil:

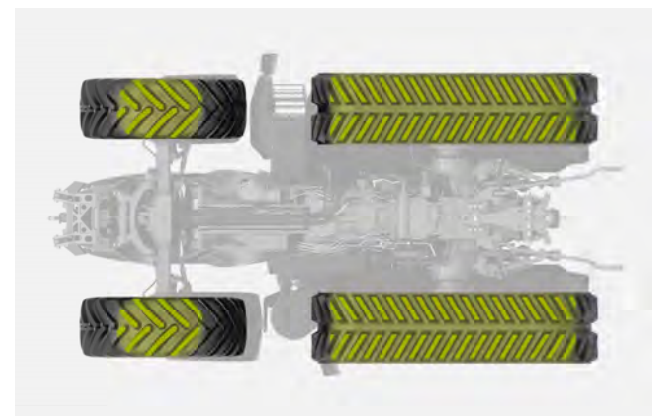

significantly less pressure means less surface compaction. So you spend far less time and energy on restructuring work.

Even more striking is the soil-protecting effect of the AXION 900 TERRA TRAC in deeper soil horizons (below 40 cm) which were not cultivated. Here, 50% less soil pressure was recorded compared to a standard tractor. Effective soil protection ensures high soil fertility in the longterm.

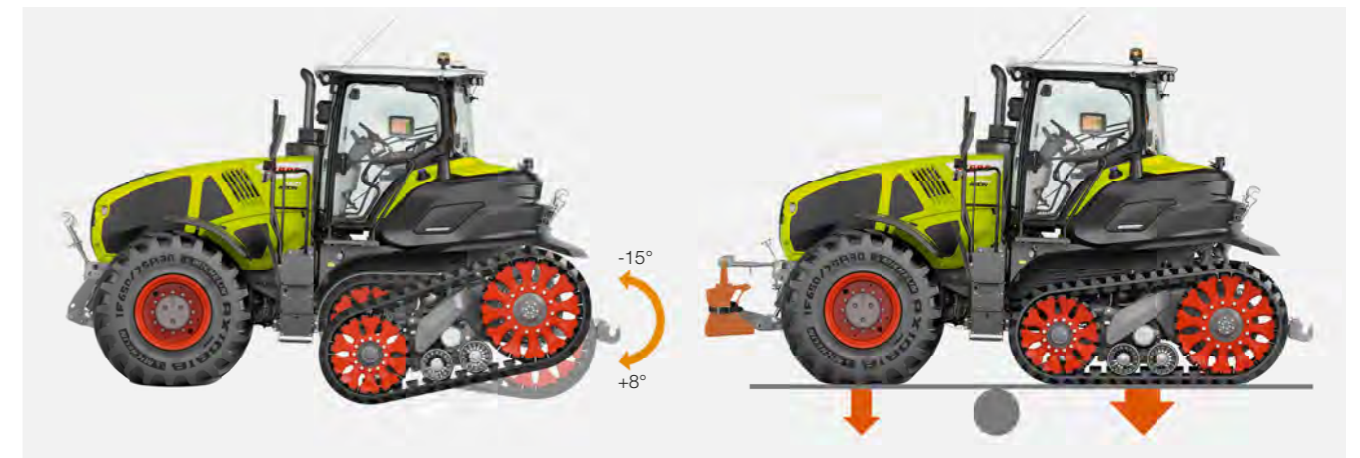

### Make the most of the TERRA TRAC concept.

The AXION 900 TERRA TRAC drives like a conventional four-wheel tractor and has front-axle steering. This allows drivers to operate the machine intuitively without having to acclimatise, and to take full advantage of all the benefits of the half-track concept.

#### Powerful traction.

The long wheel base and front axle provide effective directional stability. Both crawler track assemblies deliver their full traction potential at all times, even under varying soil conditions.

#### Steady pressure.

The vehicle's weight distribution and the implement's drawbar load have no effect on the behaviour of the TERRA TRAC crawler track units. Their oscillating motion keeps the track parallel to the ground whatever the working conditions.

#### Strength and stamina.

The front axle and crawler track unit with its large angle of oscillation easily cope with very uneven ground on farm tracks and at field entrances. So the vehicle remains stable even when using heavy implements.

#### Even with mounted implements.

Since the steering does not generate any lateral movement at the rear of the tractor, no sideways load is transmitted to attached implements. So you can use any implements you wish, even mounted ones.

#### More soil protection on the headland.

Even during tight turning manoeuvres at the headland, the crawler tracks do not drift – so the soil remains level.

#### Less front ballasting.

The front tyres on the AXION 900 TERRA TRAC makes up an even smaller proportion of the total footprint than those of the standard tractor. Most of the tractive power is transmitted by the TERRA TRAC crawler track assembly. This means that AXION 900 TERRA TRAC needs substantially less front ballasting. So you can drive with lower tyre pressure and protect your soil from the start.



Discover how TERRA TRAC protects your soil.

# Work efficiently in comfort with TERRA TRAC.

## The driving force.

The TERRA TRAC drive concept with its patented geometry combines reliable, durable components with sophisticated technology.

### Friction-locked drive.

Instead of an interrupted transmission of the drive force being provided by separate teeth, a continuous frictional drive connection is provided across the entire track.

### Automatic track tensioning.

The strong track is tensioned by an additional hydraulic ram which prevents slippage. The tension is monitored electronically at all times.

### Large drive wheels.

Large diameter ensures greater contact area with the track and enables effective power transmission.

### Self-cleaning drive wheel and guide wheel.

Spoked wheels fitted with individual rubber pads maintain close contact with the track surface. Since they are self-cleaning, they reliably transmit the driving power even under extremely muddy conditions.

### Hydropneumatic suspension.

The smart suspension system with a 120 mm travel provides a high level of driving comfort while keeping mechanical loads to a minimum. Idler wheels and support rollers with independent suspension enable ground speeds of up to 40 km/h and noticeably enhance cornering stability.



### Wheels with independent suspension.

Independent wheel suspension has distinct advantages on undulating soil surfaces. Maximum traction is achieved by keeping the entire length of the track in closer contact with the soil. And more even distribution of pressure provides even better soil protection.

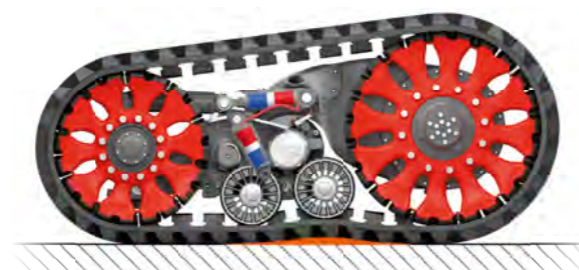

### Two track widths.

With track widths of 635 or 735 mm and corresponding front tyres, you can adapt the AXION 900 TERRA TRAC precisely to your needs. Whichever track width you choose, the tractor will not exceed the statutory road width of 3.0 m.

### 860 l fuel.

With a permissible gross weight up to 22 t and a load capacity of almost 6.0 t, the AXION 900 TERRA TRAC can handle any mounted or trailed implement.

Two fuel tanks with a combined volume of 860 l are mounted above the rear mudguards. These tanks offer the driver unrivalled autonomy by minimising the need for refuelling stops. So instead of wasting valuable time at the pump, they can spend it productively on the field.



TERRA TRAC adapts perfectly to the terrain.



## REVERSHIFT with park-lock function.

In addition to the familiar, easy-to-use clutchless reverser, the REVERSHIFT lever also has an integral park-lock function which provides a very easy way of keeping the AXION stationary. For even greater safety, the park-lock function is automatically activated in the following situations:

- When the engine is switched off
- When the engine is switched on
- If the accelerator or CMOTION have not been touched for a few seconds while the vehicle is stationary – regardless of the current REVERSHIFT lever position
- As soon as the driver's seat is vacated when the vehicle is stationary

## Automatic adjustment.

During braking, the front axle suspension automatically adjusts to the change in load. The tractor therefore retains its normal stability and safety even during sharp braking manoeuvres.

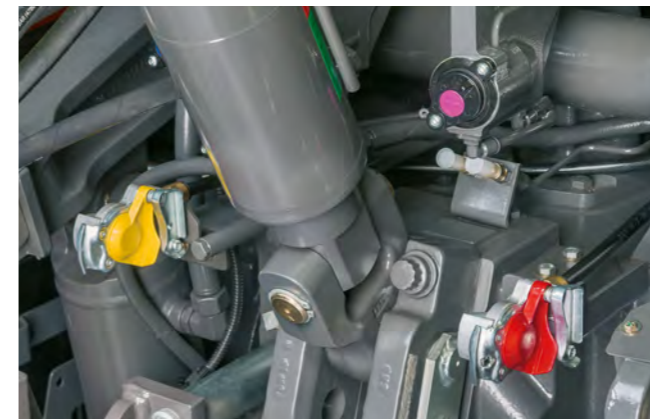

## Trailer brake system.

The AXION can be fitted with a pneumatic and a hydraulic trailer brake system in order to meet country-specific requirements. Both systems can be operated simultaneously and the connections are easily accessible on both sides of the drawbar.

Powerful and economical  
at the push of a button.

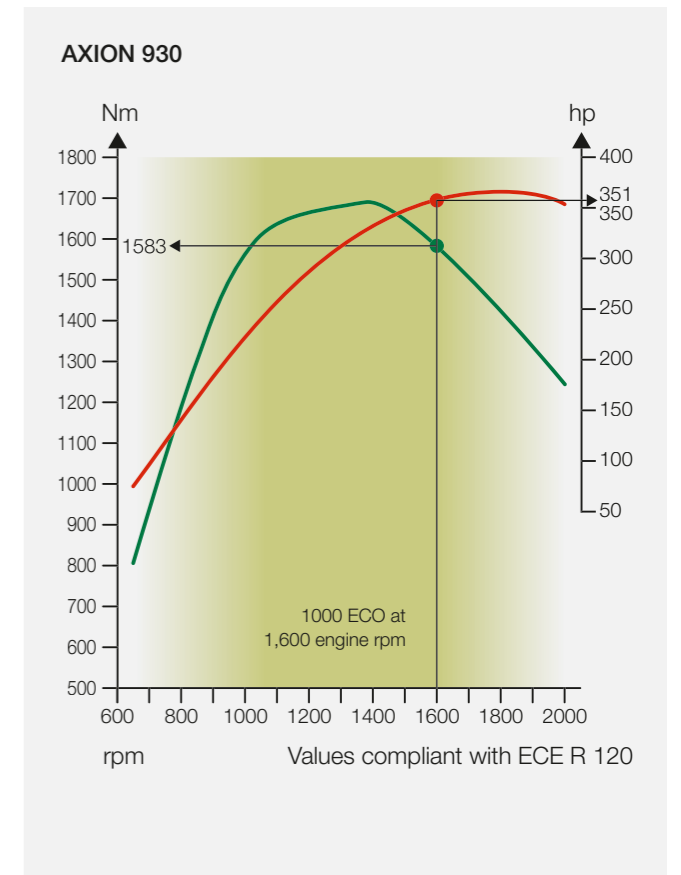

The right speed every time.

Three different PTO options are available for the AXION 900:

- 1000 rpm
- 540 ECO / 1000 rpm
- 1000 / 1000 ECO rpm

The PTO speed is easily pre-selected at the touch of a button. Another button activates the PTO.

Automatic PTO engagement/disengagement is activated at a specified linkage height which is continuously adjustable. To save the height, you just move the rear linkage to the required position and give a long press on the automatic PTO button.

The integral freewheel on the rear PTO makes implement hitching simple.



Standing start.

The AXION transfers its full power from a standing start and even at low forward speeds. Despite the reduced engine speed, in ECO mode up to 95% of maximum engine power (e.g. 351 hp and 1,583 Nm in the AXION 930) can be transmitted to the PTO shaft, enabling even heavy implements to be operated at a reduced engine speed.

- Rotational speeds:
- 1000 ECO rpm at 1,600 engine rpm
  - 540 ECO rpm at 1,450 engine rpm

NEW: PTO with the right engine speed.

A press of a button on the rear mudguard is all it takes to switch on the rear PTO and then activate the engine speed memory. Just set the right engine speed for the attached implements in CEBIS in advance. This is recommended for all operations when you routinely use the external PTO switch. It saves time and makes your job easier and safer.



The PTO stub can be changed easily.



# Powerful hydraulics. Simple connections.

## Pressure-free connections and no mess.

All the hydraulic couplings at the rear of AXION tractors have release levers, so they can be connected and disconnected even under pressure.

Coloured markings on the inlet and outlet sides make it easier to attach implements correctly. Oil leakage lines collect the oil from the couplings when attaching and removing connectors.

## Hydraulics that get the job done.

- Load-sensing hydraulic system for all AXION 900 models with 150 or 220 l/min output
- With CIS+: controls for up to six electronic spool valves on the armrest – four of which can be operated by ELECTROPILOT
- With CEBIS: controls for up to eight electronic spool valves on the armrest – four of which can be operated by ELECTROPILOT. Thanks to free assignment and prioritisation of the spool valves, every driver can adapt CEBIS operation according to the task in hand and personal preference. The frequently-used hydraulic functions are positioned side by side for smooth operation.
- With CEBIS and CIS+: spool valve operation can be assigned to the F buttons on the CMOTION, multifunction armrest or ELECTROPILOT to lighten the workload during combined operating processes.

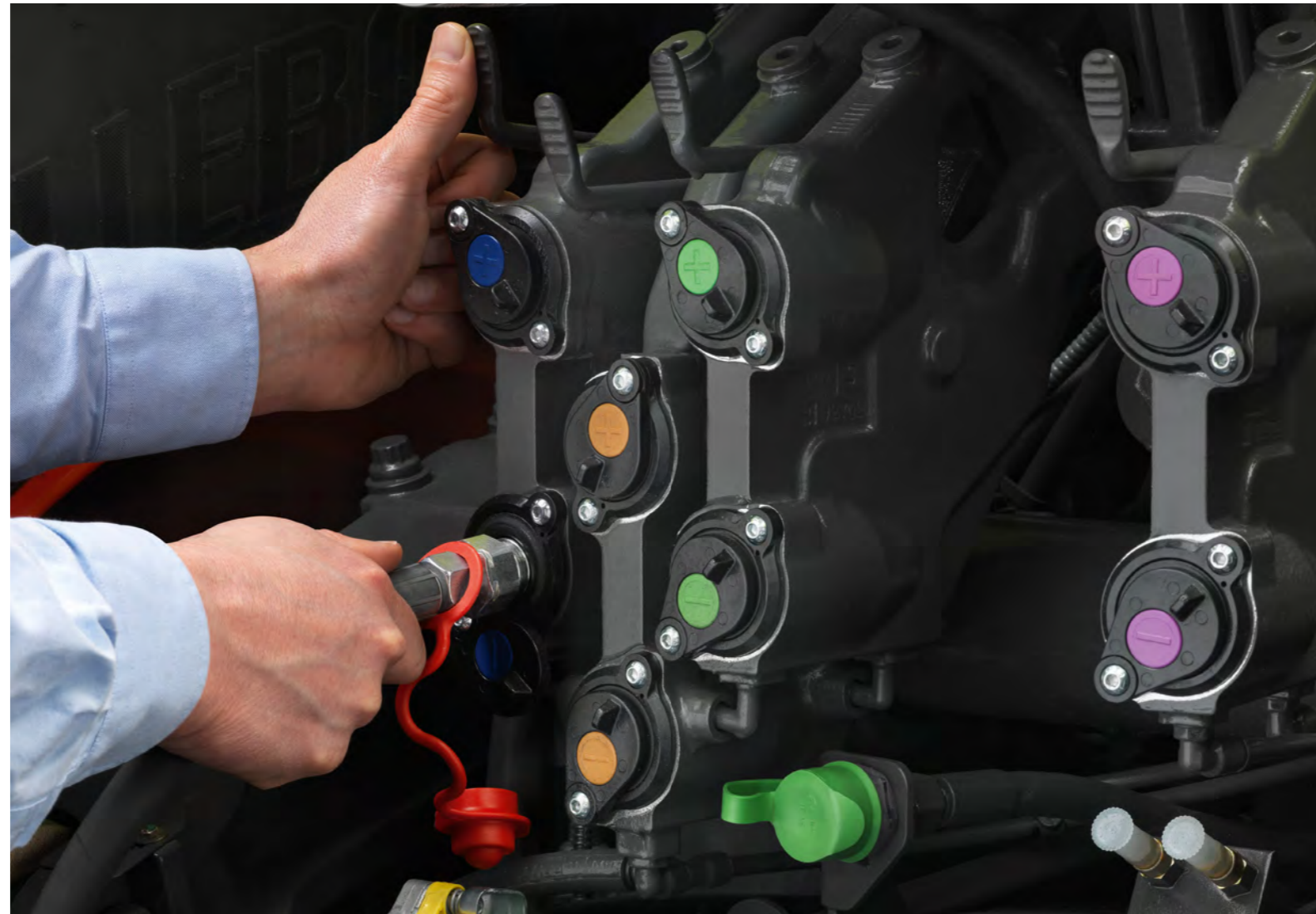

Equipment	CIS+	CEBIS
Max. number of electronic spool valves, front	2	2
Max. number of electronic spool valves, rear	4	6
Operated with a rocker switch in the armrest	2	4
Operated with ELECTROPILOT	4	4
Spool valve prioritisation	-	□
Free spool valve assignment	-	□

□ available - not available



When a front linkage is installed, up to two double-acting spool valves and one free-flow return line are available at the front. Ideal for a front-mounted seed hopper or dozer blade.

Spool valve functions are easily configured in both CEBIS and CIS.

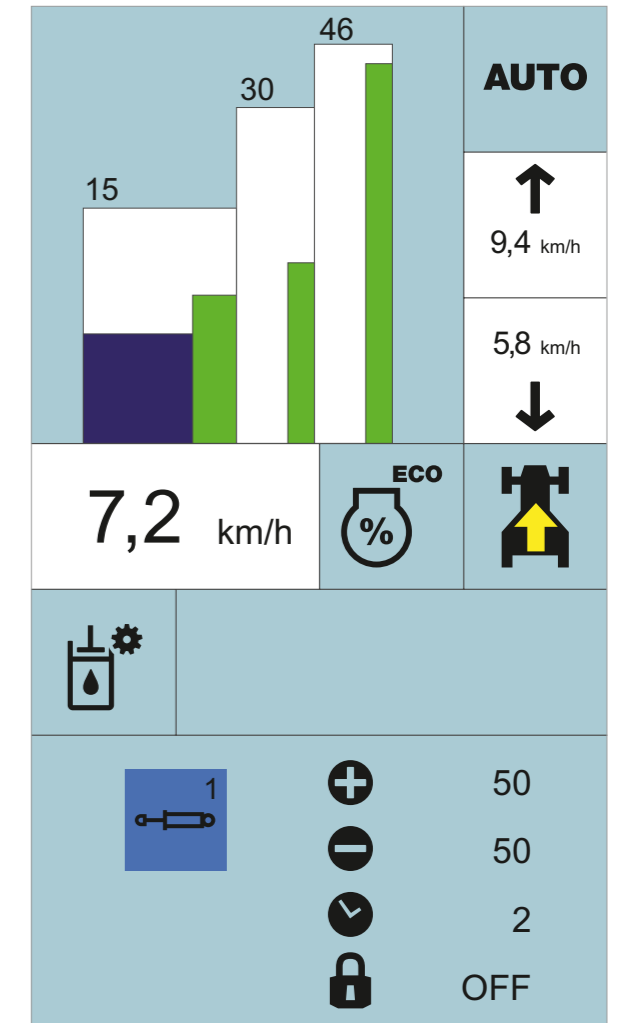

## Power Beyond.

Power Beyond connections are provided at the rear for implements with their own load-sensing control units.

In addition to the standard pressure, return and signal lines, the tractor also has a free-flow return line. The AXION is therefore prepared for operation of hydraulic motors with a separate return line, even when the Power Beyond connections are in use.

### The benefits of this are:

- Hydraulic oil is supplied to the attached implement as required
- Large-diameter lines and non-pressurised return flow reduce power losses



Lifts any implement.  
The rear linkage.



External controls for the rear linkage, PTO and one freely selectable spool valve.



The drawbar versions offer several positions. The extended position increases manoeuvrability.



A pick-up hitch is available.

### A hitch to suit every need.

The tow hitch support on the AXION 900 is ISO 500 compliant. This means that hitches on other machines which conform to the same standard can be used. A wide range of hitch options are available ex factory:

- Pick-up hitch
- In the drawbar frame:
  - Automatic clevis, 38 mm
  - K80 hitch ball
  - CUNA hitch system
- As a drawbar:
  - Cat. III or Cat. IV
  - With Piton-Fix coupling
  - With K80 hitch ball and positive steering

A number of holes are provided in the drawbar versions so that the distance between the PTO stub and hitch point can be adjusted. This gives greater flexibility and improves manoeuvrability.

### Direct adjustment.

The main rear linkage functions are directly accessed via push buttons and dials on the right-hand B-pillar:

- Manual lift and lower for machine attachment
- Vibration damping on / off
- Lock rear linkage
- Lifting height limiter and lowering speed
- Position / draught control and wheel slip control

The convex rear window and swivelling seat provide an excellent view of the implement and unimpeded operation of the rear linkage controls. The conveniently located controls enable the driver to optimise the rear linkage settings while work is in progress.

### The rear linkage.

All AXION 900 models have a maximum lifting capacity of 11 t which enables them to carry the heaviest of implements. The rear linkage configuration can be tailored to individual requirements:

- Cat. III or Cat. IV lower links
- Mechanical or hydraulic top link, Cat. III or Cat. IV
- Manual or automatic stabilisers for both lower links
- Wheel slip control via radar speed
- External controls on both mudguards for the rear linkage, PTO and one electronic spool valve
- Practical ball holder at the rear



More versatility.  
More applications.

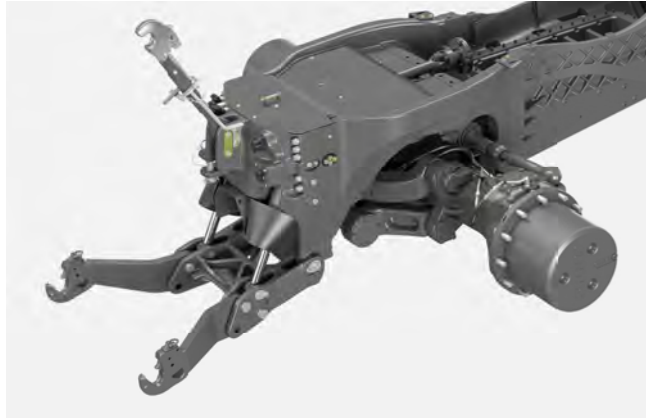

Front linkage.

All AXION 900 models can be factory-fitted with two different front linkages:

- 5.0 t for implements and ballasting
- 6.5 t for particularly heavy implements

The modular construction means that retrofitting can be carried out easily.

The AXION has a fully integrated front linkage, designed by CLAAS specifically for this power class. The front axle carrier and the special structural component for the engine are designed to absorb any forces generated, meaning no additional supports or rails are required.

A 1,000 rpm front PTO is also available. It is effortlessly engaged by pressing a button in the cab.

Compact construction

- Short distance between front axle and coupling points
- Good implement handling and short overall length



External controls for the front linkage and one spool valve.

Always connected.

Optional hydraulic and electronic interfaces for many applications are incorporated into the front linkage:

- Up to two double-acting spool valves
- Free-flow return line
- 7-pin socket
- ISOBUS connection or 25 A socket

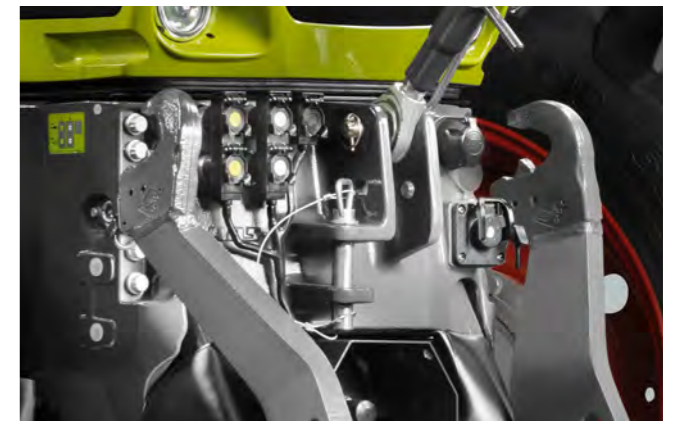

Front linkage with position control.

In the CEBIS version a position control system is optionally available for the front linkage, enabling you to work accurately with front-mounted implements.

The operating position is adjusted with a rotary knob on the armrest, and you can limit the lifting height and set the lifting and lowering speed in the CEBIS. The front linkage can be used in single- or double-acting mode.

Greater comfort  
means higher productivity.

Spacious and quiet, with large windows and full suspension. The AXION 900 cab guarantees maximum comfort throughout long working days.

- CEBIS version with touchscreen operation and the innovative CMOTION multifunction control lever.
- CIS+ version with colour display, multifunction armrest and DRIVESTICK
- Ergonomic armrest with clearly positioned and labelled controls



# A clear view. The cab.



## 4-pillar concept.

- The CLAAS 4-pillar cab offers some distinct advantages:
- Clear view of the full working width of attached implements
  - Large-volume cab creates an extremely spacious working environment
  - Continuous windscreen

The cleverly positioned rear cab pillars give the driver an excellent view of the implement and hitch area.

The layout and positioning of the controls are inspired by the design of the CLAAS AXION 800 and ARION 600 / 500 series. The controls and menu structure of the CIS+ and CEBIS versions are the same in all models. The CMOTION multifunction control lever has also become an established feature of CLAAS harvesters. CLAAS places great emphasis on having a standardised control structure so that every driver immediately feels at home in the cab and knows how to operate the controls right from the start.

## CIS+ or CEBIS.

The AXION 900 is available in two versions: the CIS+ with its functional design offers simple ergonomics and automatic functions for most applications, while the CEBIS will delight more technologically-minded users who want to enjoy the highest level of comfort. From CSM headland management through implement management to ICT (Implement Controls Tractor) – the CEBIS has plenty of functions up its sleeve.

### CIS+. Simply more.

CIS+ affords impressive ease of use and intuitive design. Despite its pleasing simplicity, it has all the necessary functionality and the automatic functions needed for effective, effortless operation. Just 'simply more'.

The 7" CIS colour display built into the A-pillar combines display and setting options for the transmission, electronic spool valves, F buttons and CSM headland management. All settings are conveniently entered using the rotary/push switch and ESC button.

### CEBIS. Simply everything.

Spool valve prioritisation, camera image, ISOBUS implement control, CEMOS, implement and job management, as well as many other functions – CEBIS meets your every need. All settings can be entered in seconds thanks to touchscreen operation and logical menu navigation, while the armrest with the CMOTION multifunction control lever offers top levels of comfort.



The cleverly positioned rear cab pillars and convex rear window give the driver an excellent view of the implement and hitch area.

AXION 900	CIS+	CEBIS
CIS colour display in the A-pillar, DRIVESTICK and multifunction armrest	●	–
CEBIS terminal with touchscreen, CMOTION multifunction control lever and multifunction armrest	–	●
Max. number of electronic spool valves	6	8
CSM headland management	□	–
CSM headland management with edit function	–	●
Implement management	–	●
Job management	–	●
On-board computer functions	●	●
Camera image	–	□
ISOBUS implement control	–	□
CEMOS	–	□
TELEMATICS	●	●
ICT (Implement Controls Tractor)	□	□

● standard □ available – not available

# CEBIS version. Simply everything.

An armrest that sets new standards.

All the main controls are integrated into the right-hand armrest:

- 1 CMOTION multifunction control lever
- 2 Control panel for drive mode, range changing and two engine speed memories with fine adjustment
- 3 CEBIS terminal with 12" touchscreen
- 4 ELECTROPILOT with two double-acting spool valves and two F buttons
- 5 CEBIS control panel
- 6 Working depth adjustment for front and rear linkage
- 7 Activate front and rear PTO
- 8 Hand throttle
- 9 Transmission in neutral, activate front linkage
- 10 Electronic spool valves
- 11 Four-wheel drive, differential lock, automatic PTO engagement/disengagement, front axle suspension
- 12 Main switch: battery, electronic spool valves, CSM, steering system

The height and position of the armrest can easily be adjusted to the driver's requirements.

Functions that are used less frequently, such as PTO speed preselection and the main switches, are located to the right of the driver's seat. When the driver's seat is rotated, the electronic linkage control system can be operated comfortably with an excellent view of the attached implement. Fine adjustment of the settings can then take place while work is in progress. Two additional buttons enable you to raise and lower the rear linkage manually for easier implement attachment.

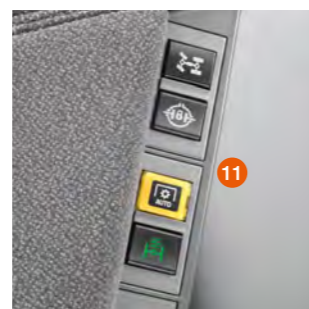

Clear, logical layout.

In both the CEBIS and CIS+ versions, many functions can be directly controlled using the rotary switches and buttons on the B-pillar:

- A PTO speed selection
- B Controls for electronic rear linkage control system
- C Rear linkage status display
- D Rear linkage settings

# CMOTION multifunction control lever. Everything in hand.

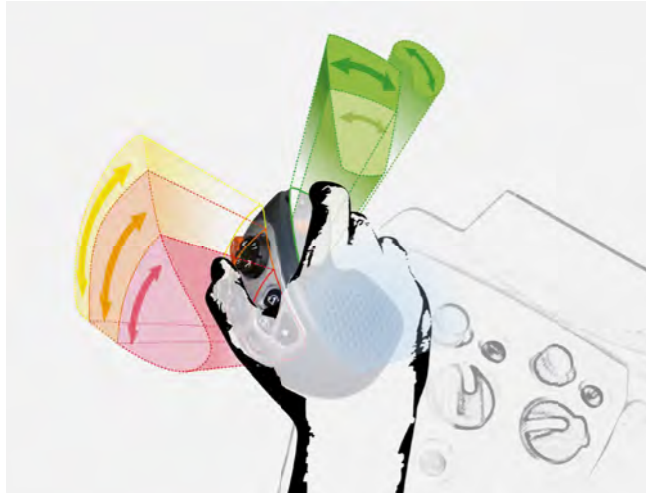

## CMOTION multifunction control lever.

The CMOTION is a CLAAS concept which makes using the main functions of the AXION 900 easier and more efficient. Functions are controlled using your thumb and forefingers, allowing your hand to stay in one place most of the time and preventing fatigue.



## CMATIC operation.

The CMOTION allows sensitive and progressive speed adjustment. The further the driver pushes the CMOTION forwards or backwards, the faster the tractor accelerates or brakes.



## At the push of a button.

- 1 Start up/change direction
- 2 Rear linkage
- 3 GPS PILOT activation
- 4 CSM headland management
- 5 Function buttons F7 / F8 / F9 / F10
- 6 Activate cruise control
- 7 Function buttons F1 / F2
- 8 Function buttons F5 / F6

The free assignment option for the ten function buttons on the CMOTION means that there is no longer any need to reposition your hands while you work. All implement-specific ISOBUS functions are easily controlled using the CMOTION:

- ISOBUS functions
- Event counter on/off
- Spool valves

Rear linkage functions on the CMOTION:

- Lower to preset working position
- Raise to the preset lift height position
- Manual activation: lift and lower at two speeds (slow/fast)
- Quick implement entry

# CEBIS terminal. Everything under control.



## Clear layout and fast operation.

The 12" CEBIS screen uses self-explanatory symbols and colour coding to give a clear picture of the settings and operating statuses. Thanks to the CEBIS menu structure and touchscreen, all settings can be entered in just a few steps. A particularly attractive feature is the DIRECT ACCESS function with the machine silhouette. Just tap the relevant area to get straight to the right dialogue window.

## An eye-catching 12" screen.

- 1 Machine silhouette for DIRECT ACCESS and status display
- 2 Spool valve status
- 3 Vehicle information
- 4 Top sub-field: performance monitor
- 5 Middle sub-field: function button assignment
- 6 Bottom sub-field: transmission information
- 7 Menu
- 8 DIRECT ACCESS via CEBIS touch button or button on the armrest
- 9 Dialogue-based system for optimum settings

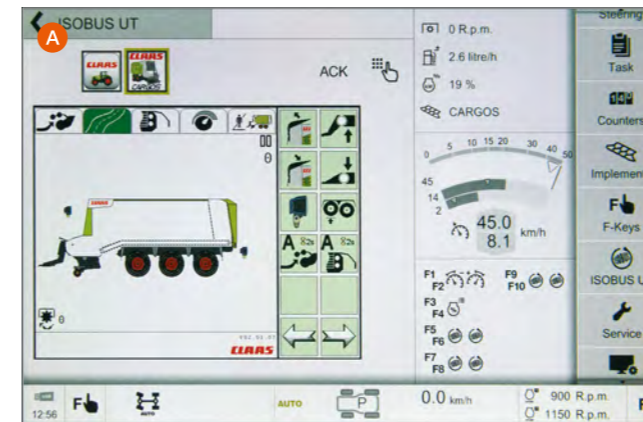

## NEW: integrated ISOBUS implement control (A).

- In CEBIS intuitively switch between ISOBUS implements, road travel and field work screen layouts
- Clear view of ISOBUS implements in main field
- Simply connect ISOBUS cable at the front or rear and off you go
- Assign up to ten ISOBUS functions to CMOTION function buttons for direct operation

## New: camera image display function (B).

- 1 Display up to two camera images in the sub-field
- 2 Toggle between machine silhouette, Camera 1 and Camera 2 in the main field

## CEBIS – simply better:

- Fast and intuitive navigation using the CEBIS touchscreen
- Rapid access to the sub-menus with the DIRECT ACCESS touch button on the CEBIS or button on the armrest
- Tap the machine silhouette, main field or sub-field
- Navigate using the rotary/push switch and ESC button on the armrest – ideal when driving on rough terrain
- Two different screen layouts available (road travel and field work)
- ISOBUS function
- Specify the user type: limit the scope of CEBIS settings to suit driver experience
- Freely assign the three sub-fields, e.g. for transmission, front and rear linkage, function buttons, headland sequences, camera or performance monitor

As well as screen-based operation with the CEBIS, there is a set of buttons in the armrest. Full CEBIS operation is available using the rotary/push switch and ESC button if uneven ground reduces the accuracy of fingertip operation. The DIRECT ACCESS button takes you straight to the settings for the last used tractor function.



- 1 Navigation in the menu
- 2 Select
- 3 ESC button
- 4 DIRECT ACCESS button





### Everything to hand.

The height and position of the armrest can easily be adjusted to the driver's requirements.



- 1 DRIVESTICK with cruise control activation to operate the CMATIC transmission
- 2 Controls for rear linkage and two F buttons, e.g. to activate CSM headland management
- 3 Hand throttle, two engine speed memories, GPS PILOT, four-wheel drive and differential lock
- 4 ELECTROPILOT four-way control lever with two F buttons and buttons to change direction
- 5 Control panel for transmission and hydraulic function activation
- 6 Electronic spool valves
- 7 Set working depth of rear linkage
- 8 Activate front and rear PTO plus automatic engagement/disengagement of rear PTO
- 9 Activate front axle suspension



### The perfectly ergonomic armrest.

The multifunction armrest has been designed for optimum ergonomics and is the key to relaxed and effective working. It's the result of extensive analyses of the operating processes in the cab: frequently required functions are located on the multifunction armrest, while those required less frequently are located on the right-hand side console.

### CEBIS does it, so does CIS+.

- Three electronic speed ranges, each with a cruise control value for both directions of travel, can be selected and activated at any time
- Set or activate individual flow and time control for individual spool valves
- Continuously variable PTO engagement/disengagement settings based on rear linkage height
- Record and run four CSM headland management sequences
- ISOBUS implements can be operated using the F buttons on the tractor
- Implement controls tractor (ICT): with QUADRANT square balers or CARGOS loader wagons

In both the CIS+ and the CEBIS versions, the rear linkage controls and preselection of PTO speeds are located on the right-hand B-pillar. They are readily available while work is in progress, enabling the driver to optimise the rear linkage control system settings when looking backwards.

### Instinctive handling.

The unique DRIVESTICK handles intuitively and gives full control of the CMATIC transmission. Unlike conventional drive levers, the DRIVESTICK comes with proportional control. This means that the further it is pushed or pulled when in drive lever mode, the faster the transmission accelerates or brakes the tractor.

This functionality is not needed so often in accelerator pedal mode as the driver controls the speed with the foot pedal. However, it is still very useful, for example to manually increase or reduce the engine braking effect.

The cruise control button is also located on the DRIVESTICK. Just press the button briefly to activate cruise control, or press and hold to save the current speed. If cruise control is active, the speed can be changed simply by moving the DRIVESTICK forwards or backwards. CIS+. Simply more.



PTO speeds and the electronic linkage control system can be adjusted on the B-pillar.

Well informed.

The CLAAS INFORMATION SYSTEM (CIS).



### CIS. The full picture.

The modern design of the 7-inch colour CIS display on the A-pillar provides the driver with full information about the transmission, rear linkage, electronic spool valves and F buttons. The settings are shown in the lower part of the screen. The logical, menu-guided interface and clear symbols make navigation very simple.

- 1 CMATIC transmission ranges
- 2 Driving mode display
- 3 Cruise control speed in the active range
- 4 Current forward speed
- 5 Selected engine droop
- 6 Selected direction of travel
- 7 Spool valve status
- 8 Rear linkage status
- 9 F button assignment
- 10 Settings menu

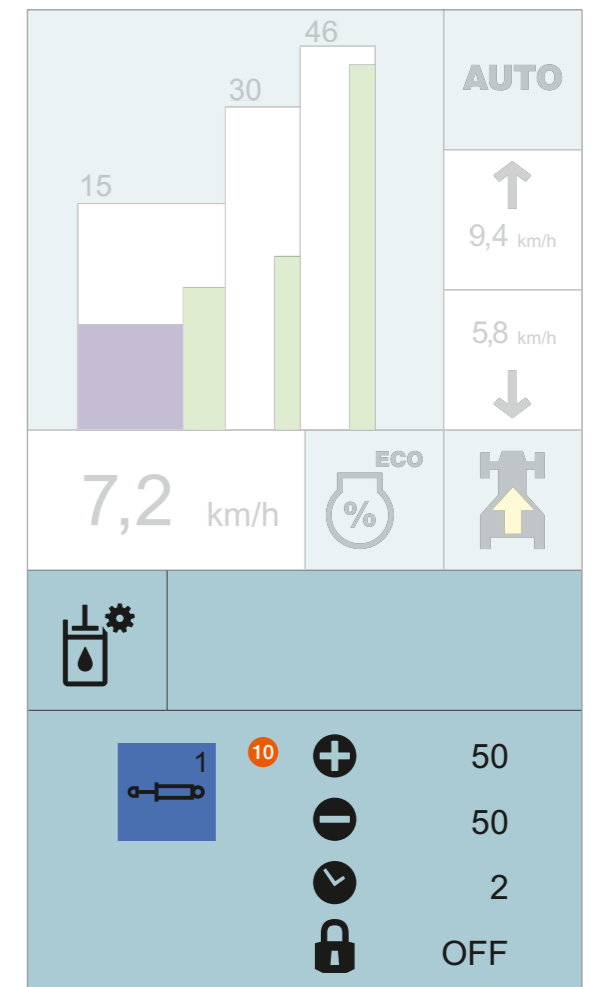

### CIS. Everything at your fingertips.

All settings are conveniently entered using the rotary/push switch and ESC button on the steering wheel. The following functions can be configured or displayed using the CIS:

- Transmission settings such as cruise control, range, acceleration, engine droop, progressivity of the REVERSHIFT clutchless reverser
- Time and volume settings for the electronic spool valves
- F button assignment
- Display of CSM headland management sequences
- On-board computer functions such as display of area worked, fuel consumption, work rate
- Maintenance interval display

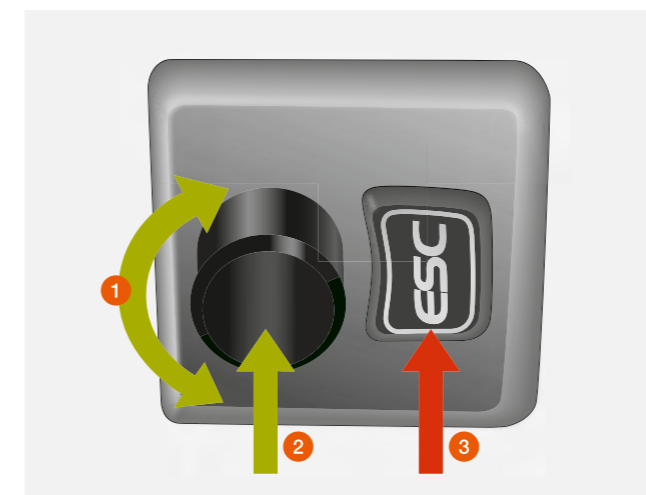

- 1 Navigation in the menu
- 2 Select
- 3 ESC button

# Ergonomics and comfort for optimum working conditions.



### First-class comfort.

Many features of the working environment make the AXION the ideal choice for long working days. A large number of storage options mean that the driver can always find space for a mobile phone or documents. Under the passenger seat there is a cooler compartment which has room for two 1.5 litre bottles and snacks. Perfect for your lunch break.

### LED headlights for perfect illumination.

If you're still working when it goes dark, the work lights will light up the whole of the area around the machine, so you can see exactly what you're doing. For even more demanding situations, up to 20 LED work lights and four LED road lights can illuminate the entire surroundings of the AXION almost as brightly as daylight.

### A pleasant working environment.

All AXION models are fitted as standard with air conditioning and, optionally, with a category 3 filter. All components are built into the double-insulated cab floor to ensure quiet operation.



As well as the manually controlled air-conditioning system, a fully automated version is available which provides a pleasant flow of air through the cab.



### NEW: non-slip leather steering wheel.

The robust leather steering wheel provides a secure grip and an uninterrupted view of the instrument panel whatever position it's in.



### Illuminated interior.

When the road lights are switched on, all the controls and the symbols on all the switches are illuminated. You have the option to select a darker colour scheme in CEBIS.



### Leather on request.

The driver and passenger seat are available with modern, non-slip fabric or elegant, easy-care leather upholstery.



### Sockets in easy reach.

All the sockets for the power supply as well as ISOBUS sockets for additional terminals are located under the right console.



### NEW: Bluetooth connection.

The built-in Bluetooth handsfree device with external microphone allows you to make clear calls from the comfort of your cab.



### Wide-angle for better visibility.

As well as the large standard mirror, a wide-angle mirror for improved road safety is supplied as standard.

# Protects both driver and machine. The suspension.

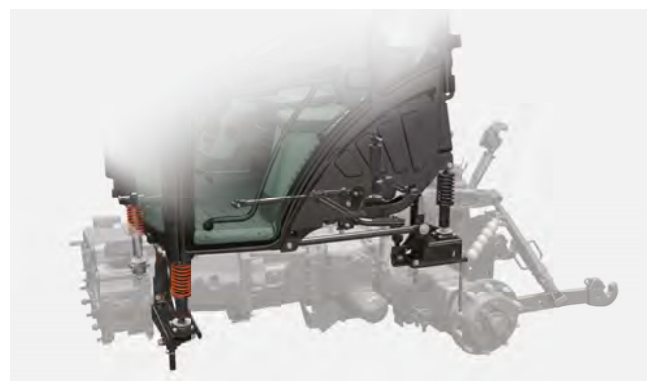

## Full 4-way suspension.

Four suspension points mean that the cab is fully isolated from the chassis, preventing impacts and vibration from reaching the driver. Longitudinal and lateral struts join the suspension points and keep the cab stable when turning corners or braking. The entire suspension system is completely maintenance-free.



## Sit better. Work better.

The wide range of seats includes a ventilated premium seat.

- Active seat ventilation makes the seat feel good whatever the weather
- Suspension automatically adjusts to the driver's weight



## PROACTIV front axle suspension – complete comfort automatically.

The suspension adjusts to tractor loading and automatically remains in the central position. Changes in load due to braking and turning manoeuvres are also compensated. Parallelogram axle suspension and 90 mm spring travel guarantee a smooth ride.



## Vibration damping.

Heavy implements mounted on the front put a strain on the tractor as well as the driver. The front and rear linkage are both equipped with vibration damping to compensate for peak loads during transport operations and when the attached implement is raised at the headland.



Experience the full-suspension cab in action.



## More traction with comfort.

The AXION 900 TERRA TRAC provides the same suspension points for the cab, front axle and linkage. The damping effect of the rear tyres is replaced by the unparalleled hydraulic suspension of the TERRA TRAC. So you can enjoy the same level of comfort in the field and on the road as the wheeled model.



Switch to activate front axle suspension.

## Operator assistance systems.

There is no substitute for your experience. It's what allows you to respond quickly and appropriately to the challenges you face in your daily work. When you're dealing with difficult terrain or changing soil conditions, you have to make decisions very quickly to get the job done to the right standard. That's why it's good to be able to count on a tractor with CEMOS to reduce your workload.

## Data management.

Data have long since become an indispensable resource. To profit from their full potential, you should take good care of them, just as you would your machinery fleet. All systems, machines and work processes have to be meaningfully connected, and data generated must be sent to many different places for analysis.



# CEMOS for tractors.

## Makes good operators even better.



CEMOS for tractors was awarded a silver medal at Agritechnica 2017.

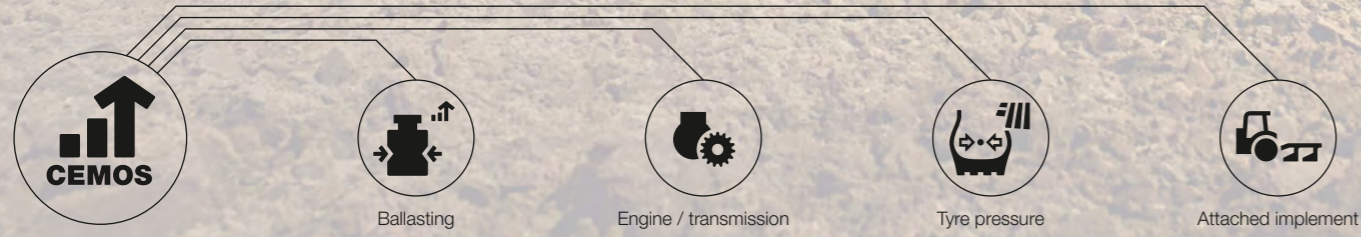

### CEMOS teaches itself and trains the user.

The CEMOS self-learning operator assistance system is the only one of its kind on the market to optimise the performance of both the tractor and attached implements such as ploughs and cultivators. So it helps the driver set the correct ballast and tyre pressure. CEMOS uses a dialogue-based interface to make recommendations for all important settings, e.g. for the engine, transmission and implement. This helps to ensure optimum traction and soil protection at all times. With CEMOS you can increase your work rate, improve the quality of your work and reduce your fuel consumption by 12%.



### Phase 1. Preparation in the farmyard.

CEMOS recommends the required ballasting and optimum tyre pressure to suit the selected implement and task before the driver has left the farmyard. The dynamic learning system gathers more measurements while work is under way, and adapts its recommendations accordingly next time around.



### Phase 2. Basic setting in the field.

The integrated CEMOS knowledge database provides step-by-step instructions on basic settings for implements, with illustrations. Assist systems are now available for all ploughs. Further implements will follow in the near future. These provide valuable assistance for drivers working with new or unfamiliar implements.

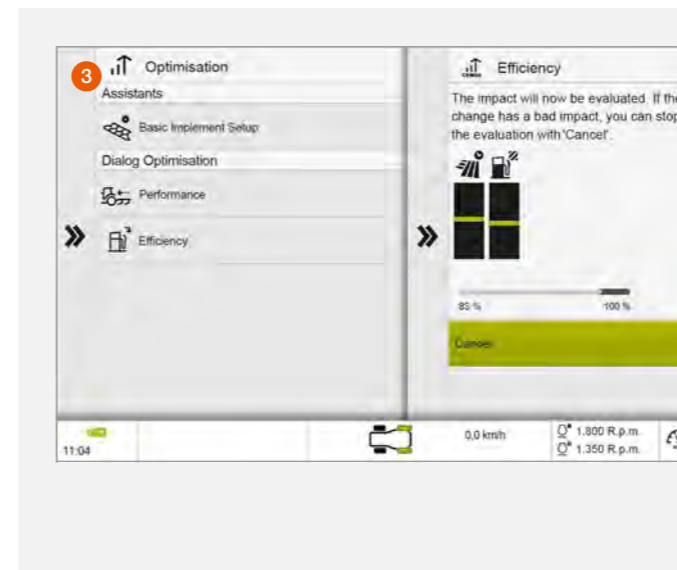

### Phase 3. Optimisation while work is under way.

The driver opens the optimisation dialogue in the field. CEMOS checks all the basic settings, and offers suggestions for improving "performance" and "efficiency", which the driver can accept or reject. After each change of setting, CEMOS recalculates and shows whether the work rate and diesel consumption have improved, and by how much.

# Precision at the headland with CSM.



## CLAAS SEQUENCE MANAGEMENT.

CSM headland management takes the load off you during all turning manoeuvres in the field. You can run any of the previously recorded functions simply by pressing a button.

	With CIS+	With CEBIS
Number of storable sequences	Four	Four per implement, up to 20 implements
Sequence activation	F buttons	CMOTION and F buttons
Sequence display	On CIS display	On CEBIS display
Recording mode	Time-related	Time- or distance-related
Edit function	—	Subsequent sequence optimisation in the CEBIS

The following functions can be combined in any order:

- Spool valves with time and flow control
- Four-wheel drive, differential lock and front axle suspension
- Front and rear linkage
- Cruise control
- Front and rear PTO
- Engine speed memory

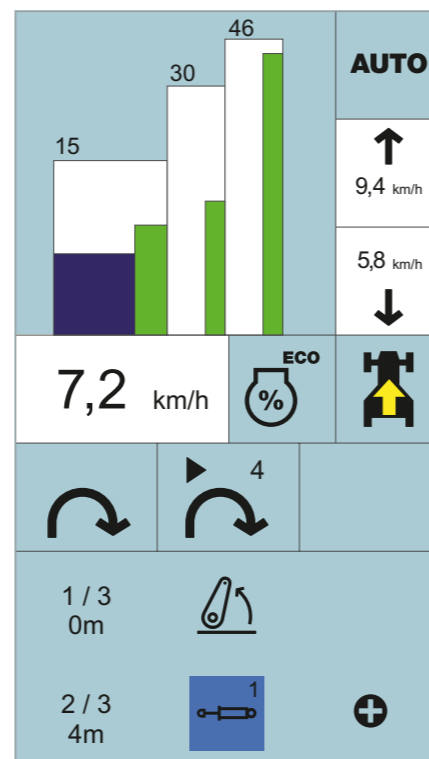

The sequence flow is shown in the lower area of the CIS colour display.

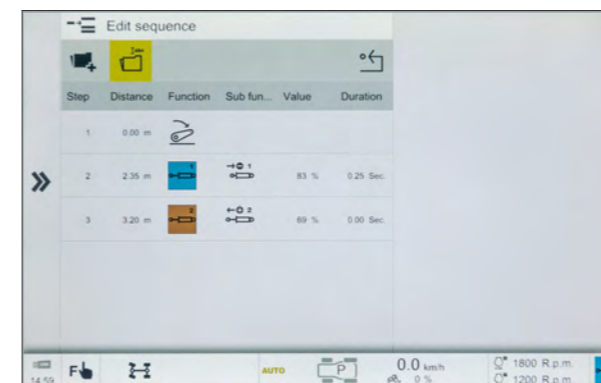

Easy to record and run.

Sequences can be recorded on a distance- or time-related basis. During recording, clear symbols allow the driver to follow the creation of the sequence step-by-step on the CEBIS or CIS colour display. A sequence that is running can be paused and restarted by simply pressing a button.

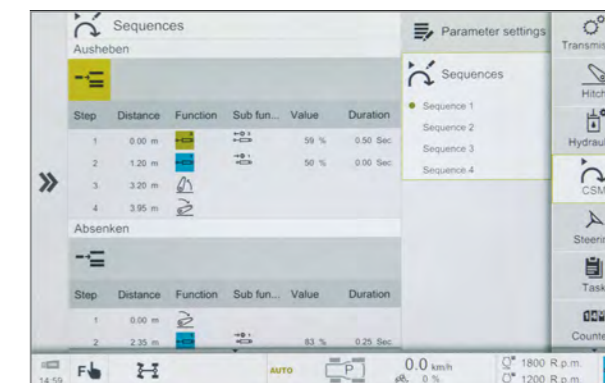

Non-stop optimisation with CEBIS.

Recorded sequences can be changed and optimised in the CEBIS at a later date. Steps can be added and deleted or changed and adapted in minute detail, allowing times, distances and flow volumes to be tailored to current conditions. Once a sequence has been recorded, it can be refined down to the last detail in just a few steps.

# Even better control with ISOBUS and ICT.



## The way you want it.

With the CEBIS version of the AXION, you can use the integrated terminal to control ISOBUS-compatible implements. Alternatively, portable displays from CLAAS offer flexible control options for ISOBUS and steering systems for all cab versions. You can also transfer the terminal from a tractor or self-propelled harvester to another machine, depending on the season or job in hand. Fit your AXION with the equipment you need straight from the factory or as a retrofit option.

### S10 terminal:

- High-resolution 10.4" touchscreen terminal
- Steering and ISOBUS functions
- Up to four cameras can be displayed

### S7 terminal:

- High-resolution 7" touchscreen terminal
- Steering functions

## EASY on board app.

With the new EASY on board app, all ISOBUS-compatible implements can be controlled from a tablet<sup>1</sup>. For even greater convenience, various functions can be assigned to the F buttons as with any other ISOBUS terminal.

## ISOBUS implement control.

Sockets are provided at the front and rear in order to connect ISOBUS-compatible implements to the tractor. The ISOBUS-enabled terminal can be connected up in the cab using another socket. The attached implement is operated by means of a machine-specific display. ISOBUS compatibility means that implements from other manufacturers can also be operated using the S10 or CEBIS terminal.

<sup>1</sup> Apple iPad devices from iOS 9. A specific list of devices is provided in the description of the EASY on board app in the Apple App Store. A CWI (CLAAS Wireless Interface) is needed to connect to the in-cab ISOBUS connection.

## Function buttons.

AXION tractors have up to ten F buttons to which different functions can be assigned in the CEBIS or CIS colour display. The current assignment can be viewed at any time in the CEBIS or CIS display window. The buttons are assigned to the corresponding function using the S10 or other ISOBUS terminals, enabling each driver to customise tractor operation to suit individual requirements.



F button assignment in CEBIS.

## AXION 900 – AEF-compliant.

The Agricultural Industry Electronics Foundation (AEF) is a partnership between approximately 150 companies, associations and organisations. Its aim is to harmonise development standards in electronic systems for agriculture, such as ISOBUS components. These systems comply with the ISO 11783 standard, but more detailed AEF guidelines are also being developed. The AXION 900 was developed according to these requirements and supports the ISOBUS functionality specifications ISO UT 1.0, TECU 1.0, AUX-O and AUX-N for ISOBUS implements.



ICT CRUISE CONTROL and AUTO STOP were awarded a silver medal at Agritechnica 2013.

## ICT (Implement Controls Tractor).

Thanks to ISOBUS, when the AXION is used in combination with the QUADRANT square baler or CARGOS loader wagon, two AXION CMATIC functions can be automatically controlled by the implement:

### ICT CRUISE CONTROL:

Optimises the performance and work quality of the implement by controlling the tractor's forward speed. The speed is continuously adjusted to suit the current conditions, enabling you to get the best out of your machine combination.

### ICT AUTO STOP:

If an overload is detected in the implement, the ICT AUTO STOP function automatically switches off the PTO. This protects the entire drive train throughout long working days and reduces the driver's workload.



# Always on the right track. CLAAS steering systems.

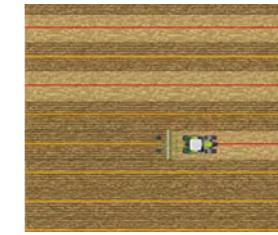

### RTK NET (accuracy $\pm 2-3$ cm)

- Correction signal via mobile phone network
- Unrestricted working radius

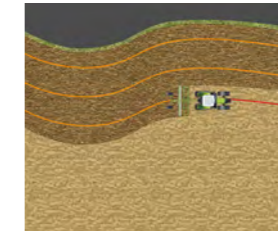

### RTK FARM BASE LINK (accuracy $\pm 2-3$ cm)

- Base station
- Station data transmitted via the mobile phone network (NTRIP)
- Operating radius 30 km

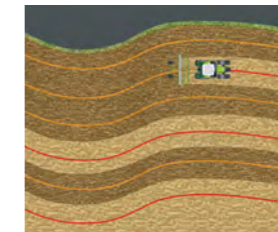

### RTK FARM BASE (accuracy $\pm 2-3$ cm)

- Base station with digital and analog radio can be used
- Range up to 15 km



### RTK FIELD BASE (accuracy $\pm 2-3$ cm)

- Mobile reference station
- Range 3-5 km

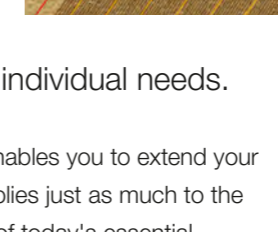

### SATCOR

- Satellite-based correction signal from CLAAS
- Virtually worldwide coverage

#### SATCOR 15 (accuracy $\pm 15$ cm)

- Improved basic accuracy
- Quick signal availability
- Good signal suitable for many applications from soil cultivation to harvesting

#### SATCOR 5 (accuracy $\pm 5$ cm)

- Ideal in areas where RTK and mobile phone coverage is patchy
- Longer initialisation period than SATCOR 15 but more accurate

### EGNOS / E-DIF (accuracy $\pm 30$ cm)

- No licence fee
- Basic accuracy

## Improve the quality of your work.

CLAAS steering systems take the pressure off the driver. They show in advance which direction to take, or automatically steer the tractor along the best possible path. Mistakes and overlapping are eliminated. Studies have shown that a modern parallel guidance system can save up to 7% on diesel fuel, machine costs, fertiliser and crop protection products.

The GPS PILOT automatic steering system is controlled by the S10 and S7 touchscreen terminals (see pages 62 / 63) which feature a very simple and user-friendly menu-guided interface.

## Automatic steering at the headland.

The AUTO TURN function takes care of turning manoeuvres at the headland. The direction of the turn and the next track to be worked are pre-selected on the terminal. The steering system does the rest.

## Correction signal to meet individual needs.

The design of the CLAAS range enables you to extend your system easily at any time. This applies just as much to the terminal technology as to the use of today's essential correction signals.

CLAAS steering systems can be used with GPS and GLONASS satellite systems to enhance their flexibility and operational capabilities.

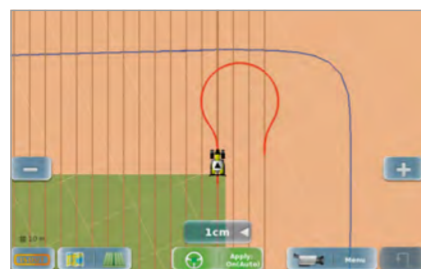

With AUTO TURN the tractor turns automatically at the headland.



Cutting your costs per hectare with more precision.  
[steeringsystems.claas.com](http://steeringsystems.claas.com)

# Keep track of all machines and jobs. All the time.

## CLAAS TELEMATICS.

TELEMATICS allows you to call up any information about your machine at any time from any location. The data collected are sent to the TELEMATICS web server via the mobile phone network.

This enables you or an authorised service partner to access and evaluate the relevant information via the internet.

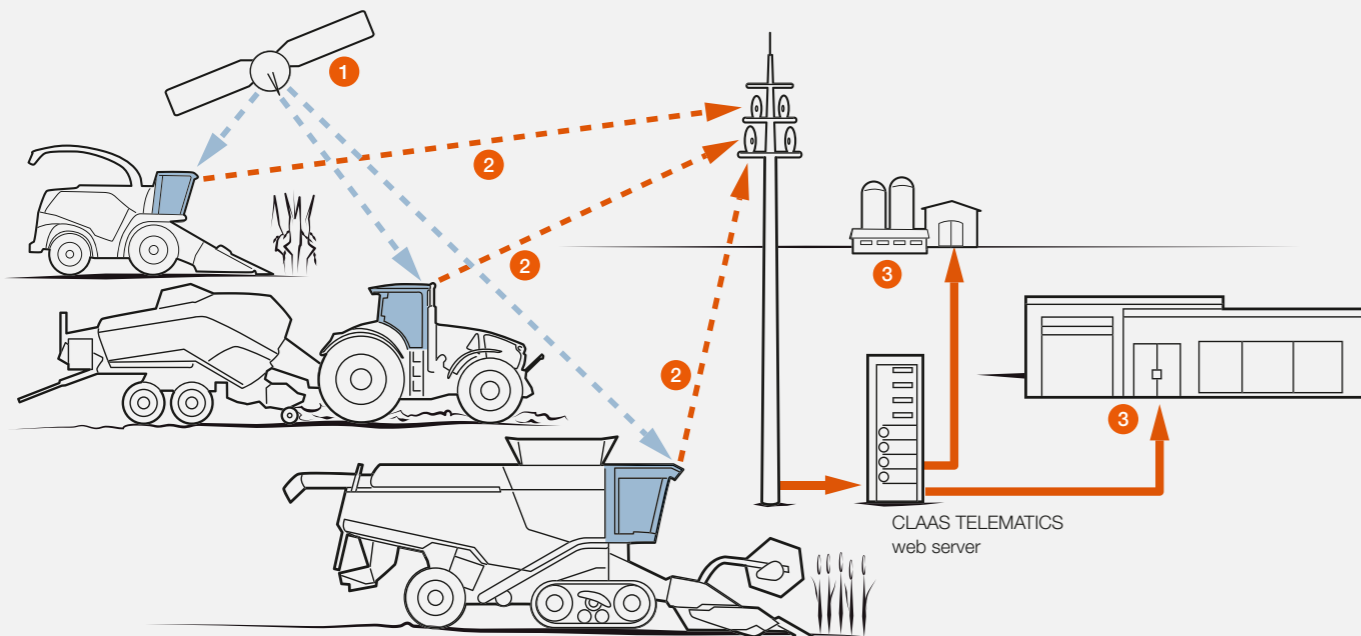

- 1 Machines receive signals transmitted by GPS satellites.
- 2 Machines send the GPS coordinates, machine-related performance data and reports to the TELEMATICS web server via the mobile phone network.
- 3 These data are directly accessible to farms or service partners via the internet.

## CLAAS TELEMATICS functions.

### Improve your work processes with operating time analysis.

- Analyse working time
- Reduce downtime
- Optimise fuel consumption

### Optimise your settings with remote monitoring.

- Position displayed in Google Earth®
- Current activity
- Review machine settings

### Simplify your documentation with data collection.

- Automatic data collection for documentation
- Secure storage on central server
- Standard interfaces for data export from TELEMATICS

### Reduce service time with remote diagnostics.

- Maintenance planning
- Remote diagnostics with CDS



Connect your machines. Optimise your jobs.  
[connected-machines.claas.com](http://connected-machines.claas.com)

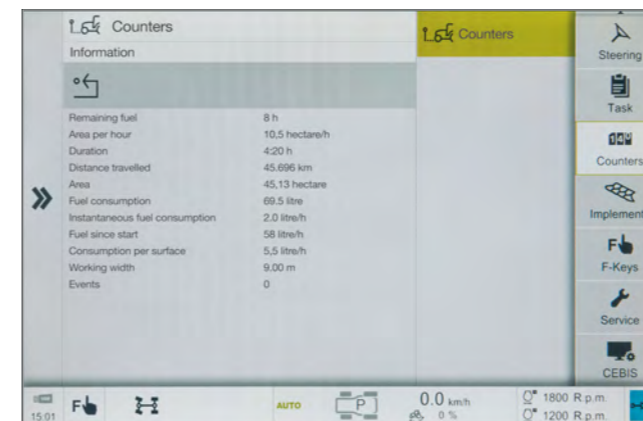

## Field management with CEBIS.

Up to 20 jobs can be set up and stored in CEBIS in order to produce documentation for the work done. Enter the working width first, then you can start area calculation and the fuel consumption display per hectare. To get the most accurate results, the speed can be measured by radar.

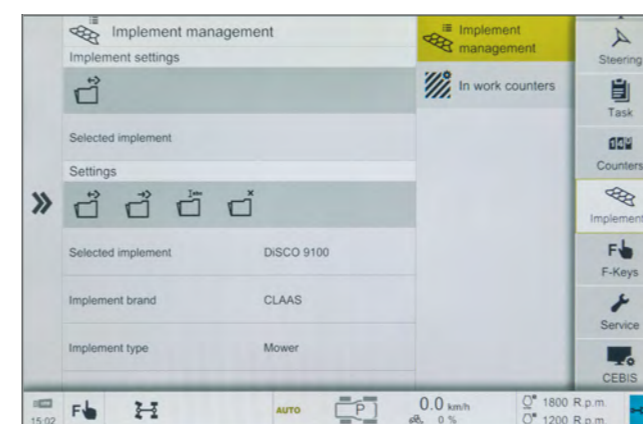

## Implement management with CEBIS.

With CEBIS, details of up to 20 implements can be recorded. All the preset values are permanently assigned to the specific implement.

- Settings for transmission and hydraulic spool valves
- Four CSM sequences
- Area calculation - mode and activation
- Working width of attached implement
- Transfer settings from one tractor to another via USB stick

This saves on unnecessary adjustment tasks when changing implement or driver. Just attach the implement, load the implement in CEBIS and start work.

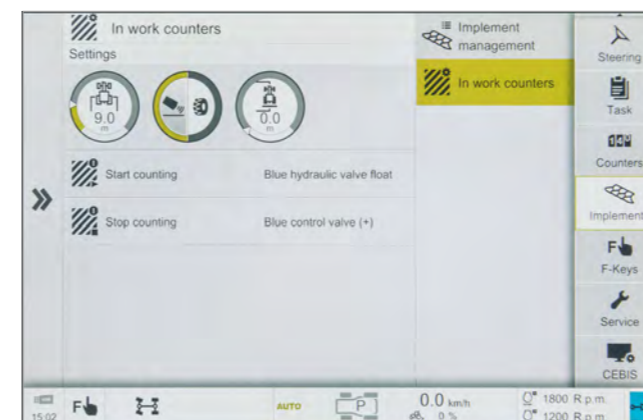

## DataConnect: the first direct cloud-to-cloud solution for agricultural machinery.

Until now, farmers with mixed machine fleets have been able to display, process and document data only at the level of individual machines or on manufacturer portals. With DataConnect, CLAAS, 365FarmNet, John Deere, Case, Steyr and New Holland have created the first direct multi-manufacturer, industry-wide open cloud-to-cloud solution. The machines transmit their data via an interface, allowing you to control and monitor your entire machinery fleet in the CLAAS TELEMATICS portal.

Maintenance provides peace of mind and retains the value.

Short maintenance times, long intervals.

In the AXION you only need to change the engine oil every 600 operating hours. And only every 1,200 hours for transmission and hydraulic oil. With all key maintenance points easily accessible, maintenance tasks can be done in next to no time – saving you money and reducing tractor downtimes.





Together, these features speed up daily maintenance tasks. This means that less working time is lost and the tractor is where it should be – at work.

### Fresh air for full power.

The large intake panels in the bonnet provide plenty of fresh air for cooling and for the engine air filter. Low flow rates at the intake panels help them to stay clean and permeable at all times.

The radiator assemblies are supported by a robust frame and gas-filled shock absorbers open the radiator panels to two positions for thorough cleaning. Cleaning can therefore be carried out safely and conveniently as required.

### Good access saves time and money.

Daily maintenance work should be as straightforward as possible – because we know from experience that nobody enjoys doing things that are complicated or inconvenient.

- The large, one-piece bonnet opens at the press of a button, providing access to all the engine maintenance points
- The engine oil can be checked and topped up on the right-hand side of the tractor when the bonnet is closed
- All daily maintenance tasks can be carried out without tools
- The fuel prefilter is conveniently located by the left-hand cab access ladder.
- Large drawer in the left-hand access ladder with space for a standard toolbox
- External battery terminals, e.g. for mobile refuelling in the field



The air filter is accessibly located in the cool zone in front of the radiator panels so it can be removed without hindrance. Coarse dirt particles are extracted in the filter housing, further extending the cleaning interval.



External battery terminals are within easy reach by the left-hand cab access ladder.



The engine air filter is in front of the radiator and easy to reach from the ground.

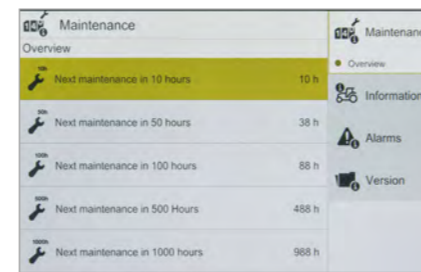

Maintenance counter in the CEBIS and CIS display.

# Whatever it takes. CLAAS Service & Parts.



### Safeguard your machine's reliability.

Increase your operating reliability, minimise the risk of breakdown and repair. MAXI CARE offers you predictable costs. Create your own individual service package to meet your particular requirements.



CLAAS Service & Parts  
is there for you 24/7.  
[service.claas.com](http://service.claas.com)



### Specially matched to your machine.

Precision-manufactured parts, high-quality consumables and useful accessories. Choose our comprehensive product range to be certain of receiving exactly the right solution to ensure 100% operating reliability for your machine.



### For your business: CLAAS FARM PARTS.

CLAAS FARM PARTS offers one of the most comprehensive ranges of multi-brand parts and accessories for all agricultural applications on your farm.



### Global supply.

The CLAAS Parts Logistics Center in Hamm, Germany, stocks almost 200,000 different parts and has a warehouse area of over 140,000 m<sup>2</sup>. This central spare parts warehouse delivers all ORIGINAL parts quickly and reliably all over the world. This means that your local CLAAS partner can supply the right solution for your harvest or your business within a very short time.



### Your local CLAAS distributor.

Wherever you are, you can count on us to always provide you with the service and the contact persons you need. Your CLAAS partners are on hand in your local area, ready to support you and your machine around the clock. With know-how, experience, commitment and the best technical equipment. Whatever it takes.

These outstanding features speak for themselves.



#### CPS.

- Full engine power available at all forward speeds and for all applications
- Low-speed concept: maximum output, maximum torque and maximum top speed at a much lower engine speed reduce operating costs significantly
- Exceptional CMATIC transmission control: dynamic, smooth and fuel-efficient
- Up to 95% of maximum engine output available to the PTO in 1000 ECO mode at 1,600 engine rpm
- Up to 220 l/min hydraulic capacity and eight electronic spool valves

#### TERRA TRAC concept.

- 15% more traction with TERRA TRAC crawler tracks
- 35% larger footprint than a conventional tractor
- 50% less ground pressure for maximum soil protection
- 100% drive comfort, even on the road
- 100% roadworthy, thanks to an external width of 3.0 m and a permissible gross weight of 22 t

#### Comfort and convenience.

- Simply more: CIS+ version with multifunction armrest and DRIVESTICK, CIS colour display in the A-pillar, electronic spool valves and CSM headland management
- Simply everything: CEBIS version with unique 3-finger operation thanks to CMOTION multifunction control lever, 12" CEBIS display with touchscreen, electronic spool valves, CSM headland management, field and implement management
- 4-point cab suspension as standard
- CEMOS for tractors
- GPS PILOT with S10 and S7 touchscreen terminal
- TELEMATICS
- ISOBUS implement control via CEBIS or S10 terminal
- ICT (Implement Controls Tractor) when the AXION is combined with the QUADRANT or CARGOS



Sales, service and support – our team is here to help.  
[contact.claas.com](http://contact.claas.com)

AXION		960 TERRA TRAC	960	950	940	930 TERRA TRAC	930	920
<b>Engine</b>								
Manufacturer		FPT	FPT	FPT	FPT	FPT	FPT	FPT
Number of cylinders		6	6	6	6	6	6	6
Cubic capacity	cm³	8710	8710	8710	8710	8710	8710	8710
Variable geometry turbo		●	●	●	●	●	●	●
Rated output (ECE R 120) <sup>1</sup>	KW/hp	323/440	323/440	298/405	280/380	257/350	257/350	235/320
Max. output (ECE R 120) <sup>1</sup>	KW/hp	327/445	327/445	301/410	283/385	261/355	261/355	239/325
Engine speed at maximum output	rpm	1800	1800	1800	1800	1800	1800	1800
Rated output type approval value <sup>2</sup>	KW/hp	330/449	330/449	301/409	283/385	258/351	258/351	233/317
Max. output type approval value <sup>2</sup>	KW/hp	332/452	332/452	308/419	290/394	265/360	265/360	240/326
Max. torque	Nm	1860	1860	1820	1770	1695	1695	1600
Engine speed at max. torque	rpm	1400	1400	1400	1400	1400	1400	1400
Max. fuel tank capacity	l	860	640	640	640	860	640	640
Oil-change interval	h	600	600	600	600	600	600	600
<b>CMATIC continuously variable transmission</b>								
REVERSHIFT clutchless reverser		●	●	●	●	●	●	●
Min. speed at rated engine speed	km/h	0.05	0.05	0.05	0.05	0.05	0.05	0.05
Max. speed	km/h	40	40/50	40/50	40/50	40	40/50	40/50
<b>Rear axle</b>								
Max. diameter of rear tyres	m	–	2.20	2.20	2.20	–	2.20	2.20
Widest rear tyres		–	900/60 R 42	900/60 R 42	900/60 R 42	–	900/60 R 42	900/60 R 42
Flanged axle		–	–	–	–	–	●	●
Quick-release axle 2.5 or 3.0 m wide		–	●	●	●	–	○	○
Width of crawler track units 635 or 735 mm		●	–	–	–	●	–	–
Automatic differential lock		●	●	●	●	●	●	●
Park-lock		●	●	●	●	●	●	●
Oil-change interval	h	1200	1200	1200	1200	1200	1200	1200
<b>PTO</b>								
External operation of engagement and emergency stop		●	●	●	●	●	●	●
1000	rpm	●	●	●	●	●	●	●
540 ECO / 1000	rpm	○	○	○	○	○	○	○
1000 / 1000 ECO	rpm	○	○	○	○	○	○	○
PTO stub 1 1/8", 6, 8 or 21 splines, and 1 3/4", 6 or 20 splines		□	□	□	□	□	□	□
<b>Four-wheel drive front axle</b>								
Rigid front axle		–	●	●	●	–	●	●
PROACTIV front axle suspension		●	○	○	○	●	○	○
Automatic 4-wheel drive		●	●	●	●	●	●	●
Optimum turning radius	m	7.75	6.96	6.96	6.96	7.75	6.96	6.96
<b>Hydraulics</b>								
Load-sensing circuit		●	●	●	●	●	●	●
Max. output, standard (option)	l/min	150 (220)	150 (220)	150 (220)	150 (220)	150 (220)	150 (220)	150 (220)
Number of electronic spool valves in CIS+ version		–	3-6	3-6	3-6	–	3-6	3-6
Number of electronic spool valves in CEBIS version		4-8	3-8	3-8	3-8	4-8	3-8	3-8

<sup>1</sup> Meets ISO TR 14396

<sup>2</sup> Performance data fit criteria for admissibility.

● standard ○ optional □ available – not available

AXION		960 TERRA TRAC	960	950	940	930 TERRA TRAC	930	920
<b>Rear linkage</b>								
Max. lifting capacity at ball ends	kg	10500	11250	11250	11250	10500	10950	10950
Continuous lifting power at 610 mm	kg	7690	7690	7690	7690	7520	7520	7520
Cat. III hook		●	●	●	●	●	●	●
Cat. IV hook		○	○	○	○	○	○	○
Vibration damping		●	●	●	●	●	●	●
External controls		●	●	●	●	●	●	●
Active wheel slip control		○	○	○	○	○	○	○
<b>Front linkage</b>								
Max. lifting capacity at ball ends with 5 t model	kg	5185	5185	5185	5185	5185	5185	5185
Max. lifting capacity at ball ends with 6.5 t model	kg	6513	6513	6513	6513	6513	6513	6513
Cat. III hook		●	●	●	●	●	●	●
Vibration damping		●	●	●	●	●	●	●
Position control		○	○	○	○	○	○	○
External controls for front linkage		○	○	○	○	○	○	○
Front PTO		○	○	○	○	○	○	○
Four additional hydraulic connections and one free-flow return line		○	○	○	○	○	○	○
External controls for additional connections		○	○	○	○	○	○	○
ISOBUS and trailer socket		○	○	○	○	○	○	○
<b>Cab</b>								
CIS+ version		–	●	●	●	–	●	●
CEBIS version		○	○	○	○	○	○	○
Air conditioning		●	●	●	●	●	●	●
Automatic climate control		○	○	○	○	○	○	○
Passenger seat with integral cool box		●	●	●	●	●	●	●
<b>Data management and operator assistance systems</b>								
CEMOS		–	○	○	○	–	○	○
CSM headland management		●	○	○	○	●	○	○
ISOBUS and ICT		○	○	○	○	○	○	○
GPS PILOT ready		○	○	○	○	○	○	○
GPS PILOT steering system		○	○	○	○	○	○	○
TELEMATICS		●	●	●	●	●	●	●

CLAAS continually develops its products to meet customer requirements. This means that all products are subject to change without notice. All descriptions and specifications in this brochure should be considered approximate and may include optional equipment that is not part of the standard specifications. This brochure is designed for worldwide use. Please refer to your nearest CLAAS dealer and their price list for local specification details. Some protective panels may have been removed for photographic purposes in order to present the function clearly. To avoid any risk of danger, never remove these protective panels yourself. In this respect, please refer to the relevant instructions in the operator's manual. All technical specifications relating to engines are based on the European emission regulation standards: Stage. Any reference to the Tier standards in this document is intended solely for information purposes and ease of understanding. It does not imply approval for regions in which emissions are regulated by Tier.

● standard ○ optional □ available – not available

AXION		960 TERRA TRAC	960	950	940	930 TERRA TRAC	930	920
-------	--	-------------------	-----	-----	-----	-------------------	-----	-----

**Dimensions and weights**

Standard

Height: centre of rear axle to cab roof (a)	mm	2427	2427	2427	2427	2427	2427	2427
Length: front linkage folded, cat. IV rear lower links (b)	mm	6248	5744	5744	5744	6248	5744	5744
Wheelbase (c)	mm	2950	3150	3150	3150	2950	3150	3150
Weight	kg	16200	13000-14000	13000-14000	13000-14000	16200	12500-13500	12500-13500



Ensuring a better **harvest**.

CLAAS KGaA mbH  
 Mühlenwinkel 1  
 33428 Harsewinkel  
 Deutschland  
 Tel. +49 5247 12-0  
 claas.com